

TIMKEN**The Timken Company**

4500 Mt Pleasant St. NW

N. Canton, OH 44720

Phone: (234) 262-3000

E-Mail: CustomerCAD@timken.com • Web site: www.timken.com

Part Number 3204 ATN1/C3, Timken® Double Row Angular Contact Ball Bearings (3200, 3300)

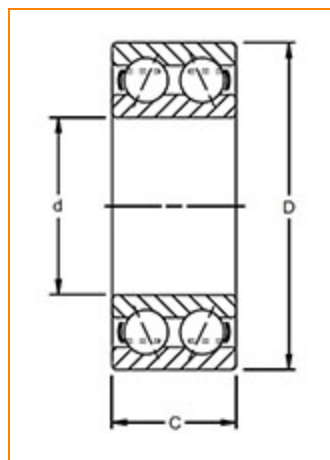

[Dimensions](#) | [Specifications](#) | [Basic Load Ratings](#) | [Abutment and Fillet Dimensions](#)

Dimensions

d - Bore	20.00 mm 0.7874 in
D - Outer Diameter	47.00 mm 1.8504 in
C - Ring Width	20.6 mm 0.8110 in
Contact Angle	30 °

Specifications

Features	Open
Ball Type	STEEL



Cage Type	Molded
Cage Material	Nylon
Bearing Weight	0.17 Kg 0.364 lb
Design Units	METRIC

Basic Load Ratings

C0 - Static Radial Rating	10400 N 2338 lbf
C1 ISO - Dynamic Radial Rating	15300 N 3439 lbf

Abutment and Fillet Dimensions

R - Inner Ring "To Clear" Radius ¹	1.00 mm 0.039 in
r - Outer Ring "To Clear" Radius ²	1.00 mm 0.039 in
da - Inner Ring Backing Diameter	25.6 mm 1.008 in
Da - Outer Ring Backing Diameter	41.4 mm 1.630 in

¹ Maximum housing fillet radius that bearing corners will clear.

² Maximum shaft fillet radius that bearing corners will clear.

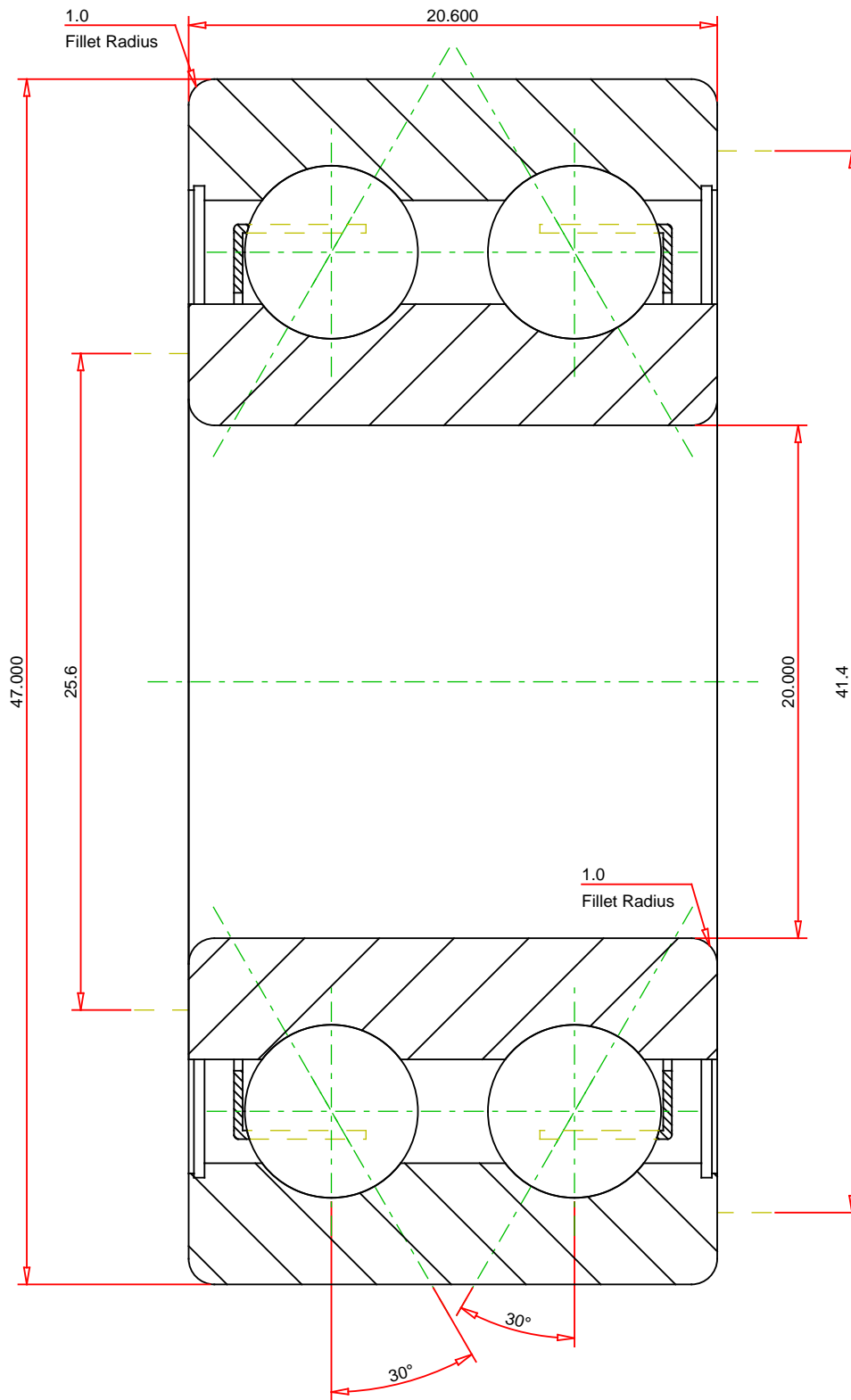

METRIC UNITS

Number of Balls Per Row	18
Bearing Weight	0.170 kg

TIMKEN®

THE TIMKEN COMPANY
NORTH CANTON, OHIO USA

3204 ATN1/C3	
Timken® Double Row Angular Contact Ball Bearings (3200, 3300)	
Dynamic Load Rating	15300 N
Static Load Rating	10400 N

Every reasonable effort has been made to ensure the accuracy of the information contained in this writing, but no liability is accepted for errors, omissions or for any other reason.

FOR DISCUSSION ONLY